



CONVEYOR COMPONENTS COMPANY

Division of Material Control, Inc.

130 Seltzer Road, PO Box 167 • Croswell, MI 48422 USA

PHONE: (810) 679-4211 • TOLL FREE (800) 233-3233 • FAX: (810) 679-4510

Email: info@conveyorcomponents.com • <http://www.conveyorcomponents.com>

MODELS: CT-105, CT-106 AND CT-107 with CT-200G / CT-201G SERIES

Intrinsically safe output for Class I, Groups A, B, C, & D; Class II, Groups E, F, & G locations when used with CT-G series probes.

WARNING:

DEATH or SERIOUS INJURY may occur.

Before installing or adjusting, shut down and physically lock-out the conveyor system.

Only controls and probes described in these instructions, when properly connected, meet intrinsically safe requirements. To prevent ignition of flammable or combustible atmospheres, disconnect power before servicing. Substitution of components may impair intrinsic safety.

Control Unit Specifications:

Input Supply Voltage:	120 VAC @ 50/60 Hz; 240 VAC (suffix B)
Power Consumption:	10 Watts
Probe Voltage Output:	12 VDC
Output Relay:	DP/DT 5 Amps, 120 VAC Resistive 5 Amps, 240 VAC Resistive
Time Delay VR1:	0.1 to 35 Seconds. This adjustment will delay output relay action.
Enclosure:	CT-105/CT-105B: Type 4X CT-106/CT-106B: Type 4X, Class II, Groups E, F and G (Type 9) CT-107/CT-107B: Class I, Groups C and D, Class II, Groups E, F and G (Types 7 & 9)
Indicator Lights:	Normal (green): Light on when relay is energized. Alarm (red): Light on when relay is de-energized.
Logic Selector S1:	This switch determines when the output relay actuates and de-actuates. Position 1: Relay energizes when the probe is in the vertical position. Relay de-energizes when probe is in the tilted position. Middle: Null; no contact <u>DO NOT USE</u> this position. Position 2: Relay energizes when probe is in the tilted position. Relay de-energizes when probe is in vertical position.

Probe Specifications:

Each probe contains one SP/ST, normally closed, mercury or non-mercury switch. Probe options available are stainless steel construction, paddle for use in applications where the materials are moving, and threaded coupling.

'G' series probes rated Intrinsically Safe for Class I, Groups A, B, C and D; Class II, Groups E, F and G only when used with control models CT-105, CT-106 or CT-107 (includes suffix B and/or E models).

CT-201G:	Standard heavy-duty probe model; 9" [23 cm] long
CT-200G:	Compact probe model; 6" [15 cm] long.
Probe signal voltage:	12 VDC
Probe ratings:	1.5 A @ 120VAC, 0.75 A @ 220VAC, 1.5 A @ 0-50VDC
Probe actuation angle:	15° (13°- 25°) from vertical
CT-201GN:	Non-Mercury heavy-duty probe model; 9" [23 cm] long
CT-200GN:	Non-Mercury compact probe model; 6" [15 cm] long
Probe signal voltage:	12 VDC
Probe ratings:	0.25 A max., 60 V max., 3 VA max.
Probe actuation angle:	Break 25° (15°- 25°) from vertical; Remake 8° min.

Installation Instructions:

Mounting (Refer to Figures 8-10):

The control unit should be mounted in an area free from vibration with maximum ambient temperature 40°C/104° F. Consideration should be given to mounting the unit where indicator lights will be visible to the necessary personnel, and wiring may be easily installed to the probe and other machinery.

Wiring:

Field wiring must meet or exceed the requirements of the National Electrical Code and any other agency or authority having jurisdiction over the installation. The control enclosures are equipped with three ¾ NPT conduit connection openings.

CT-105: Use threaded close-up plug rated for Type 4X enclosures or better in the unused conduit entry. If the probe is to be used in hazardous locations, the control must be installed in a non-hazardous atmosphere, and the probe cable must have a conduit seal, UL Listed or CSA Certified for use in Class I and Class II Hazardous locations, installed where the cable passes through into the hazardous atmosphere location.

CT-106 or CT-107: Use close-up plugs and conduit seals that are UL Listed or CSA Certified for use in Class I and Class II Hazardous locations. Conduit seals must be installed within 18" [45 cm] of the control enclosure.

The probe connection cable, attached to the probe, is 16-3 type SO. The probe cable connects to the CT controller only through the conduit opening labeled, "INTRINSICALLY SAFE WIRING ONLY." Length is supplied as specified per order, up to 5,000 ft. [1524 m] maximum (probe cable may be spliced). If not specified, the probe is supplied with 25 ft. [7.62 m] of cable.

Probe Installation (Refer to Figures 5-10):

The probe should be suspended using a fixed support, such as the CT-400 mounting bracket and CT-500 S-hook, at a position where it will easily intercept the bulk material at the desired indication point. There must be a free flow of material both to and away from the probe. In some installations, it is necessary to install a baffle or shield above the probe assembly to protect it from product surges.

Troubleshooting Suggestions:

1. Verify input voltage to controller is appropriate (120 VAC or 240 VAC).
2. Use a continuity meter to check tilt probe operation when disconnected from the electrical circuit. Circuit is normally closed (NC) when probe is vertical, and normally open (NO) when probe is tilted (toward horizontal).
3. Use a paddle or float ball in conjunction with tilt probe for fine or small grained material that does not allow probe to tilt.
4. Verify the logic selector switch is in correct position.
 - Position 1: Relay energizes when the probe is in the vertical position.
Relay de-energizes when probe is in the tilted position.
 - Middle: Null state with no contact: DO NOT USE.
 - Position 2: Relay energizes when probe is in the tilted position.
Relay de-energizes when probe is in vertical position.
5. Verify an input voltage has been applied to the relay common (COM) terminal.
6. The probe connection board fuse (non-replaceable) may be blown. Remove the two base holding screws along with the electronics assembly. Remove the 4 nuts and lock-washers from the corners of the electronics assembly, and carefully remove the probe connection board from the mounting bracket. Check the 50 mA (12 V) fuse with a continuity checker. If the fuse is open (no continuity), replace the entire probe connection board assembly, as the fuse is not field replaceable.

Figure 2: Control Board Wiring Terminals

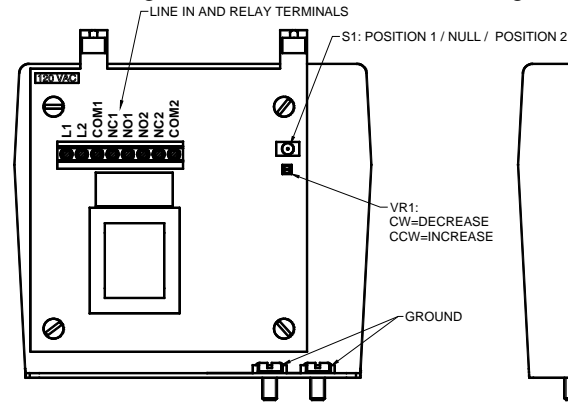

Figure 3: Control Board Probe Wiring Terminals

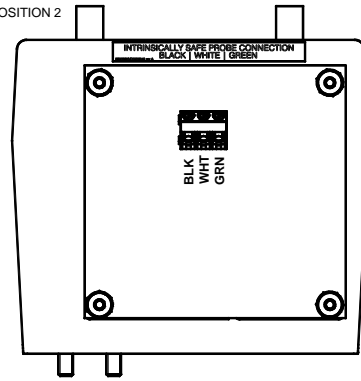

Figure 3: Control Dimensions

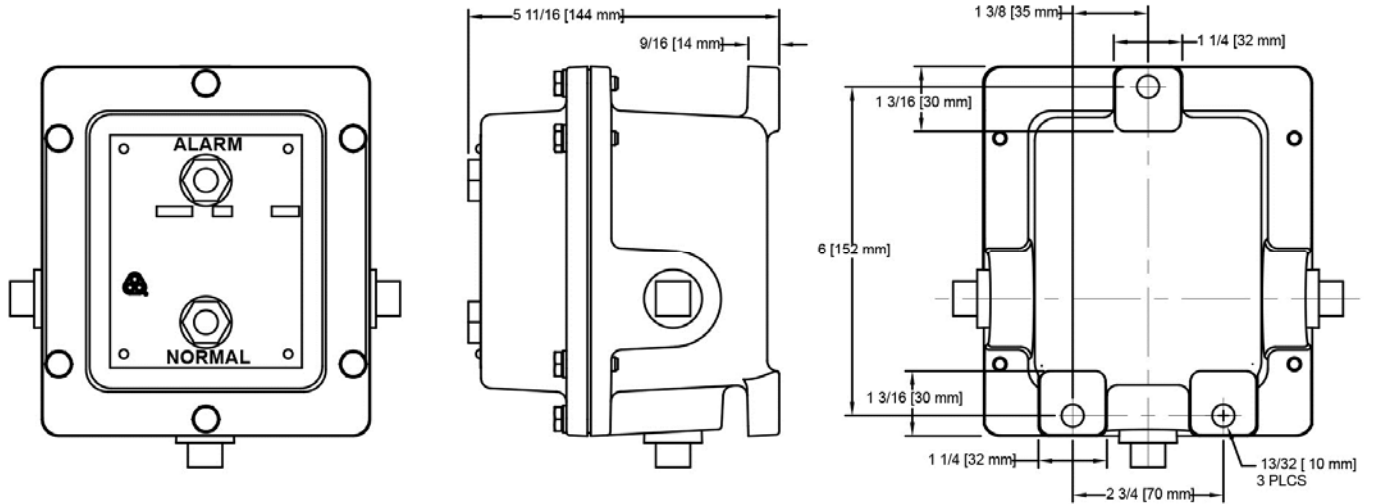

Figure 4: Probe Dimensions

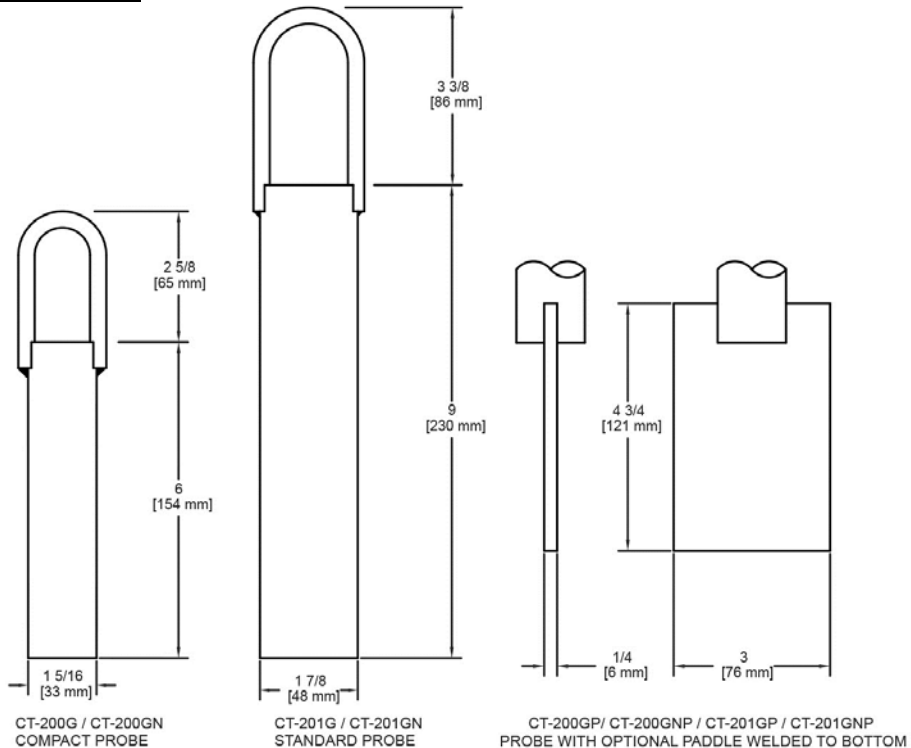

Figure 5: Typical Installations

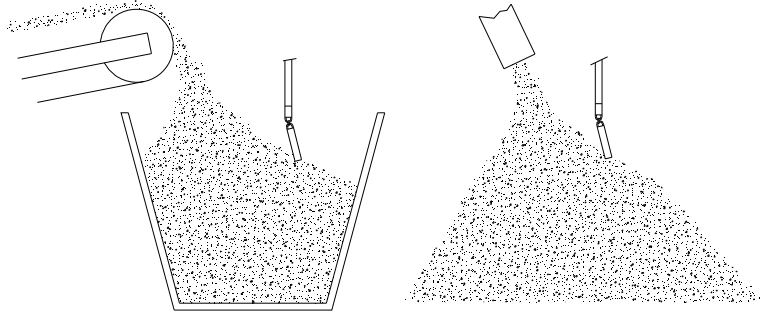

Figure 6: CT-200GP Probe with Paddle

Figure 7: CT-200GC with CT-600 Float Ball



Figure 8: Typical CT-105 and CT-201G Probe Application with Different Environments

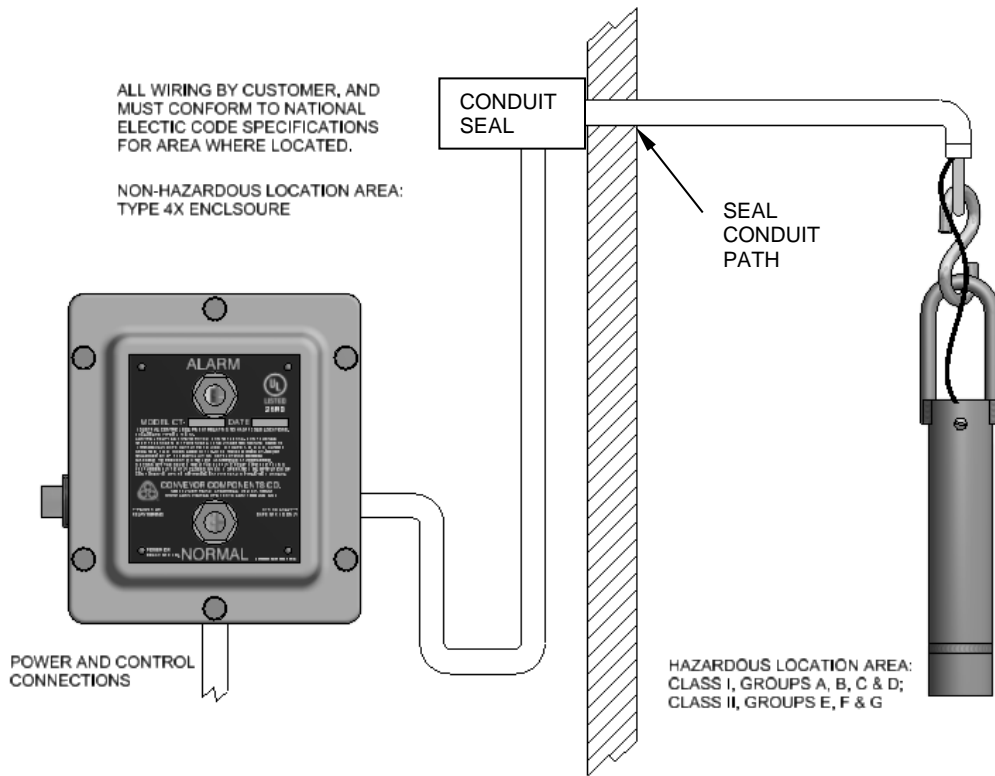

Figure 9: Typical CT-106 with CT-201G Probe Application with Different Environments

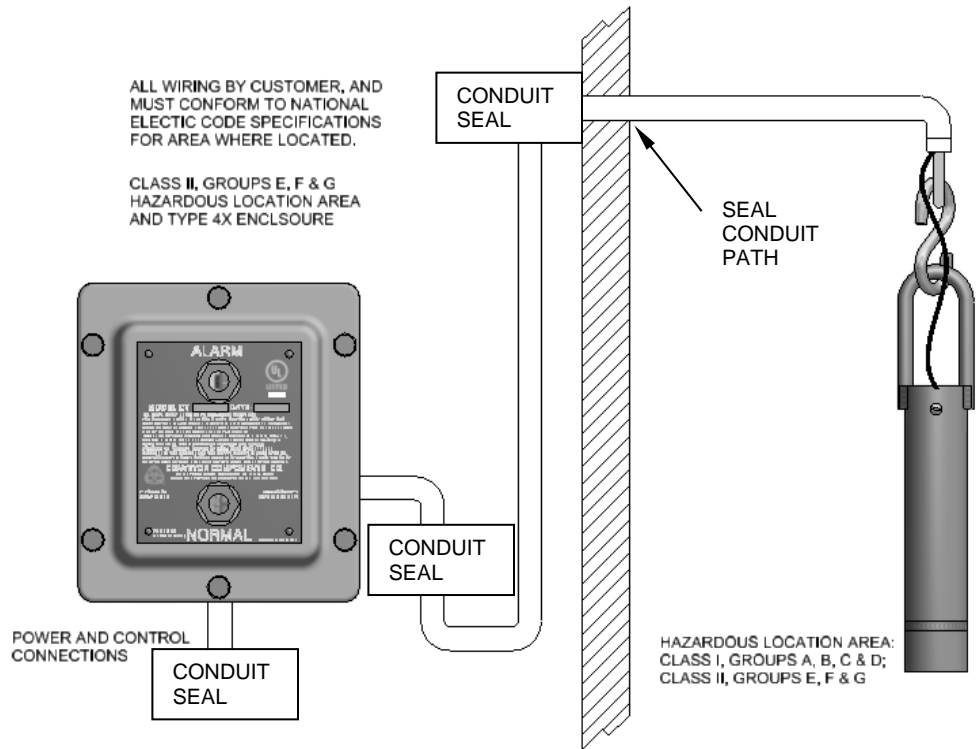

Figure 10: Typical CT-107 and CT-201G Probe Application with Different Environments

